

COPYRIGHT © Hangzhou EZVIZ Software Co., Ltd.. ALL RIGHTS RESERVED.

Any and all information, including, among others, wordings, pictures, graphs are the properties of Hangzhou EZVIZ Software Co., Ltd. (hereinafter referred to as “EZVIZ”). This user manual (hereinafter referred to as “the Manual”) cannot be reproduced, changed, translated, or distributed, partially or wholly, by any means, without the prior written permission of EZVIZ. Unless otherwise stipulated, EZVIZ does not make any warranties, guarantees or representations, express or implied, regarding to the Manual.

About this Manual

The Manual includes instructions for using and managing the product. Pictures, charts, images and all other information hereinafter are for description and explanation only. The information contained in the Manual is subject to change, without notice, due to firmware updates or other reasons. Please find the latest version in the EZVIZ™ website (<http://www.ezvizlife.com>).

Revision Record

New release – January, 2019

Trademarks Acknowledgement

EZVIZ™, ™, and other EZVIZ's trademarks and logos are the properties of EZVIZ in various jurisdictions. Other trademarks and logos mentioned below are the properties of their respective owners.

Legal Disclaimer

TO THE MAXIMUM EXTENT PERMITTED BY APPLICABLE LAW, THE PRODUCT DESCRIBED, WITH ITS HARDWARE, SOFTWARE AND FIRMWARE, IS PROVIDED “AS IS”, WITH ALL FAULTS AND ERRORS, AND EZVIZ MAKES NO WARRANTIES, EXPRESS OR IMPLIED, INCLUDING WITHOUT LIMITATION, MERCHANTABILITY, SATISFACTORY QUALITY, FITNESS FOR A PARTICULAR PURPOSE, AND NON-INFRINGEMENT OF THIRD PARTY. IN NO EVENT WILL EZVIZ, ITS DIRECTORS, OFFICERS, EMPLOYEES, OR AGENTS BE LIABLE TO YOU FOR ANY SPECIAL, CONSEQUENTIAL, INCIDENTAL, OR INDIRECT DAMAGES, INCLUDING, AMONG OTHERS, DAMAGES FOR LOSS OF BUSINESS PROFITS, BUSINESS INTERRUPTION, OR LOSS OF DATA OR DOCUMENTATION, IN CONNECTION WITH THE USE OF THIS PRODUCT, EVEN IF EZVIZ

HAS BEEN ADVISED OF THE POSSIBILITY OF SUCH DAMAGES. TO THE MAXIMUM EXTENT PERMITTED BY APPLICABLE LAW, IN NO EVENT SHALL EZVIZ'S TOTAL LIABILITY FOR ALL DAMAGES EXCEED THE ORIGINAL PURCHASE PRICE OF THE PRODUCT.

EZVIZ DOES NOT UNDERTAKE ANY LIABILITY FOR PERSONAL INJURY OR PROPERTY DAMAGE AS THE RESULT OF PRODUCT INTERRUPTION OR SERVICE TERMINATION CAUSED BY: A) IMPROPER INSTALLATION OR USAGE OTHER THAN AS REQUESTED; B) THE PROTECTION OF NATIONAL OR PUBLIC INTERESTS; C) FORCE MAJEURE; D) YOURSELF OR THE THIRD PARTY, INCLUDING WITHOUT LIMITATION, USING ANY THIRD PARTY'S PRODUCTS, SOFTWARE, APPLICATIONS, AND AMONG OTHERS.

REGARDING TO THE PRODUCT WITH INTERNET ACCESS, THE USE OF PRODUCT SHALL BE WHOLLY AT YOUR OWN RISKS. EZVIZ SHALL NOT TAKE ANY RESPONSIBILITIES FOR ABNORMAL OPERATION, PRIVACY LEAKAGE OR OTHER DAMAGES RESULTING FROM CYBER ATTACK, HACKER ATTACK, VIRUS INSPECTION, OR OTHER INTERNET SECURITY RISKS; HOWEVER, EZVIZ WILL PROVIDE TIMELY TECHNICAL SUPPORT IF REQUIRED. SURVEILLANCE LAWS AND DATA PROTECTION LAWS VARY BY JURISDICTION. PLEASE CHECK ALL RELEVANT LAWS IN YOUR JURISDICTION BEFORE USING THIS PRODUCT IN ORDER TO ENSURE THAT YOUR USE CONFORMS TO THE APPLICABLE LAW. EZVIZ SHALL NOT BE LIABLE IN THE EVENT THAT THIS PRODUCT IS USED WITH ILLEGITIMATE PURPOSES.

IN THE EVENT OF ANY CONFLICTS BETWEEN THE ABOVE AND THE APPLICABLE LAW, THE LATTER PREVAILS.

Package Contents

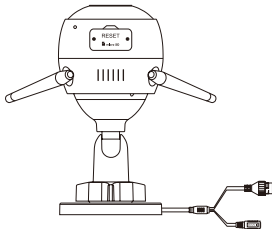

Wi-Fi Camera



Drill Template



Screw Kit



Waterproof Kit



Power Adapter



Regulatory Information



Quick Start Guide

Basics

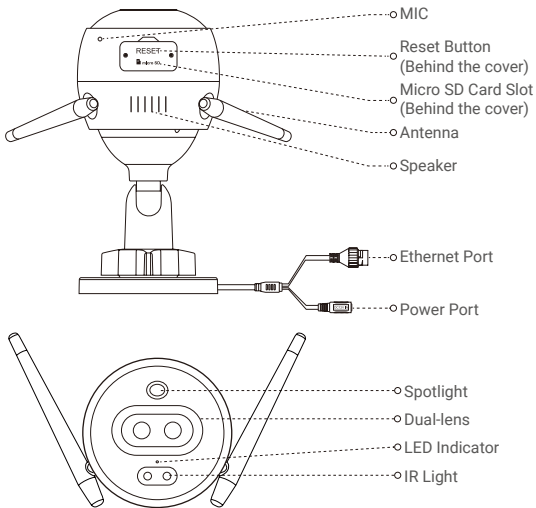

Name

LED Indicator

Description

- Solid Red: Camera starting up.
- Slow-flashing Red: Wi-Fi connection failed.
- Fast-flashing Red: Camera exception (e.g. Micro SD card error).
- Solid Blue: Video being viewed in the EZVIZ app.
- Slow-flashing Blue: Camera running properly.
- Fast-flashing Blue: Camera ready for Wi-Fi connection.

Get the EZVIZ app

1. Connect your mobile phone to Wi-Fi using your 2.4GHz network.
2. Search for "EZVIZ" in App Store or Google Play^(TM).
3. Download and install the EZVIZ app.
4. Launch the app, and register an EZVIZ user account.

Setup

Follow the steps to set your camera:

1. Power on your camera.
2. Log in to your EZVIZ app user account.
3. Connect your camera to the Internet.
4. Add your camera to your EZVIZ account.

How to Set Your Wi-Fi Camera?

1 Power-on

Steps:

1. Connect the power adapter cable to the camera's power port.
2. Plug the power adapter into an electrical outlet.

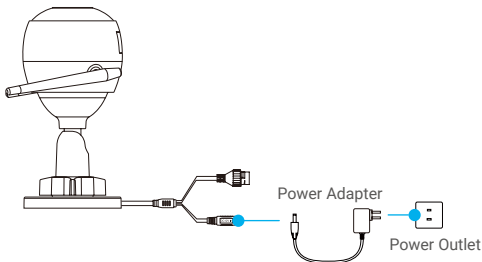

-  The LED turning fast-flashing blue indicates that the camera is powered on and ready for Wi-Fi configuration.

2 Connect to the Internet

- Wireless Connection: Connect the camera to Wi-Fi. Refer to [Option 1](#).
- Wired Connection: Connect the camera to a router. Refer to [Option 2](#).

Option 1: Use the EZVIZ app to configure Wi-Fi.

Steps:

1. Log in to your account using the EZVIZ app.
2. On the Home screen, tap “+” on the upper-right corner to go to the Scan QR Code interface.

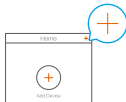

3. Scan the QR code on the Quick Start Guide cover or on the body of the camera.

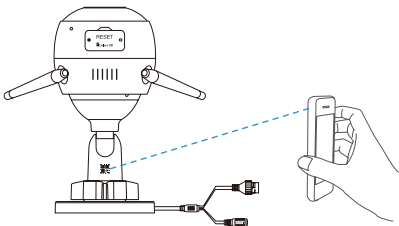

4. Follow the EZVIZ app wizard to finish Wi-Fi configuration.

- Please choose to connect the same Wi-Fi for your camera as your mobile phone has connected.
- Hold the reset button for 5s to restart and set all parameters to default. Hold the reset button for 5s in any of the following cases:
 - The camera fails to connect to your Wi-Fi network.
 - You want to change to another Wi-Fi network.

Option 2: Connect your Wi-Fi camera to a router.

Steps:

1. Connect the camera to the LAN port of your router with the Ethernet cable.

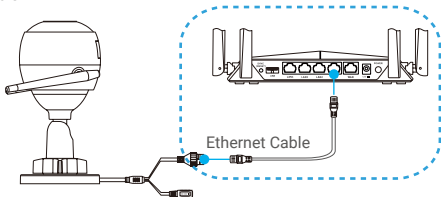

2. Log in to your account using the EZVIZ app.
3. On the Home screen, tap "+" on the upper-right corner to go to the Scan QR Code interface.

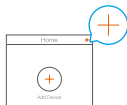

4. Scan the QR code on the Quick Start Guide cover or on the body of the camera.

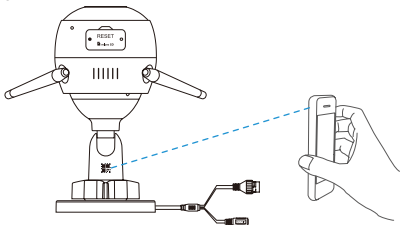

5. Follow the wizard to add the camera to the EZVIZ app.

Installation (Optional)

1 Install the Micro SD Card (Optional)

1. Remove the cover on the camera.
2. Insert the micro SD card (sold separately) into the card slot as shown in the figure below.
3. Place the cover back on.

i After installing the micro SD card, you should initialize the card in the EZVIZ app before using it.

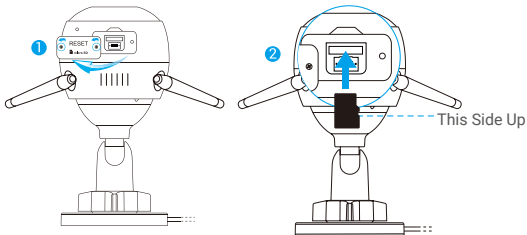

4. In the EZVIZ app, tap the Storage Status in the Device Settings interface to check the SD card status.
5. If the memory card status displays as Uninitialized, tap to initialize it.

i The status will then change to Normal and it can store videos.

2 Install the Camera

The camera can be mounted on the wall or ceiling. Here we take wall mounting as an example.

- i** • Recommended installation height: 3 m (10 ft).
 - Make sure the wall/ceiling is strong enough to withstand three times the weight of the camera.
 - Avoid positioning the camera in an area that gets a lot of light shining directly into the camera lens.
- Place the drill template onto the surface you have chosen to mount the camera.
 - **(For cement wall/ceiling only)** Drill screw holes according to the template, and insert three anchors.
 - Use three metal screws to fix the camera according to the template.

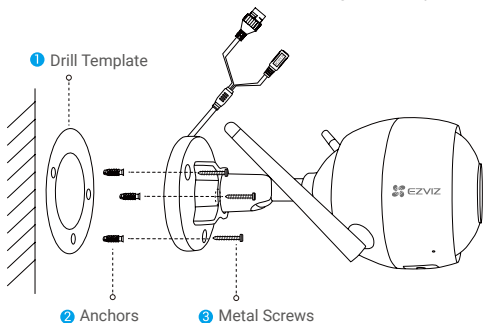

- i** Please tear up the drill template after installing the base if needed.

3 Adjust the Surveillance Angle

- Loosen the adjusting screw.
- Adjust the surveillance angle for a best view of your camera.
- Tighten the adjusting screw.

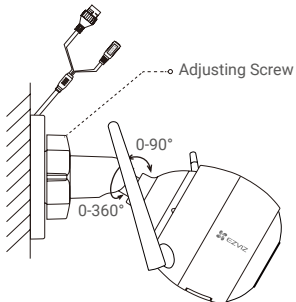

i Make sure the micro SD card slot is facing downward.

EXPOSURE TO RADIOFREQUENCY RF

The frequency bands and the nominal limits of transmitted power (radiated and/or conducted) applicable to this radio device are the following:

Band	Wi-Fi 2.4 GHz
Frequency	From 2.412 GHz to 2.472 GHz
Power transmission (EIRP)	100 mW

i For detailed information, please visit www.ezviz.eu.